

BASELINE RESTORER

BLR1

Amptek's **BLR1** restores the baseline in high counting rate applications. The BLR1 is typically used with the A275, A203, and A225. In order to simplify testing and prototype work, the PC-275 test board is also available.

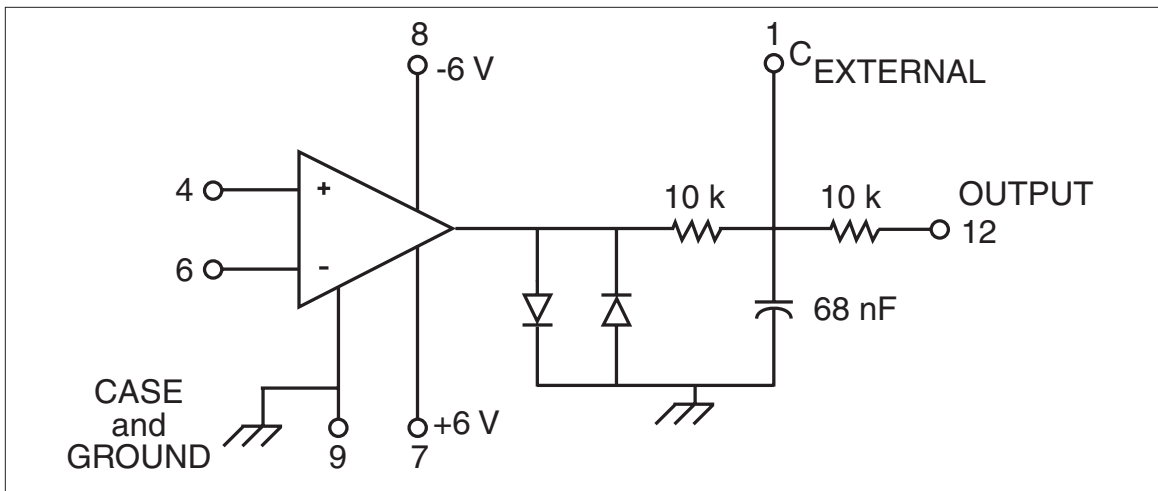
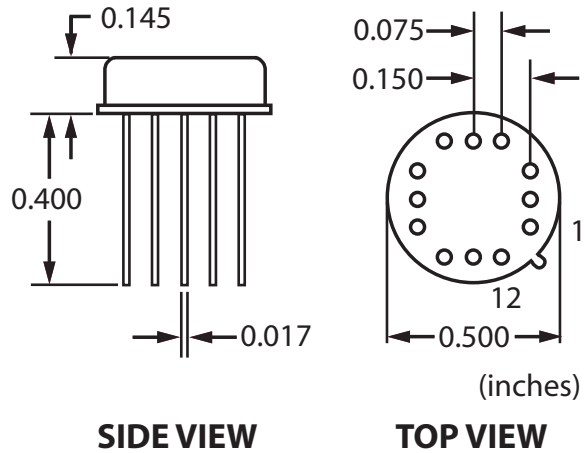

BLR1 PIN CONFIGURATION

PIN	FUNCTION
1	External capacitor to ground (as necessary to achieve loop stability ~10 μ F)
4	+ Input
6	- Input
7	+6 V (At 2.5 ma)
8	-6 V (At 2.5 ma)
9	Ground & case
12	Output (If the unit oscillates, use Pin 1 for Output with an external 10 K, replacing the internal 10 K.)
2, 3, 5, 10, 11	No connection

THEORY OF OPERATION

The BLR1 is a transconductance amplifier with transconductance of approximately 17ma/Volt and very wide bandwidth. In operation, it amplifies both the DC baseline component and the pulse signal component by a large factor. Typically, with the PIN 12 output connected to a low impedance, the amplifier load is the internal 20kΩ resistor. The low frequency voltage gain at the amplifier output is 17ma/Volt x 20kΩ = 340. The amplified pulses are clipped by the pair of Schottky diodes to an amplitude of ±0.5V and thus have little influence on the average output of the amplifier, which is dominated by the amplified baseline. This output is then passed through a low-pass RC filter formed by the first 10kΩ and the total capacitance (internal and external) from PIN 1 to ground. The filtered output is fed back to the input of the shaping amplifier chain to zero the baseline at the output of the amplifier chain.

EXAMPLE

Assume both BLR1 and the amplifier chain have zero offset voltage, so that in the absence of pulses the BLR1 output is zero, since no correction is required. Now assume 1μs pulses are present at the output of the amplifier chain at a rate of 10⁵/s. At the output of the BLR1 amplifier, this will produce a 10% duty cycle waveform with peak amplitude of 0.5V. In order that the average of this signal be near zero volts, the baseline at this point will have to shift downward by (0.5V ÷ 9) = 56mV. Dividing by the amplifier gain of 340, we get a baseline shift at the input of the BLR1 of just minus 160μV. To generalize:

$$\text{Baseline Shift} = \frac{0.5V (t_w n)}{A_v (1 - t_w n)}$$

where: t_w = pulse width (near baseline)
 n = pulse rate (c.p.s.)
 A_v = BLR1 amplifier voltage gain (normally about 340)

Note that when the duty cycle reaches 50%, the baseline shift at the output of the BLR1 amplifier will reach -0.5V, at which point negative clipping will occur and the baseline can no longer be maintained. This can be considered to be BLR “saturation.”

The above example is an ideal case. In a real case, there are several complicating factors which must be considered:

- 1) There is not a single pulse width, since the effective width is dependent on amplitude, with a larger pulse appearing to be wider. Thus, the pulse height spectrum influences the saturation count rate.
- 2) The statistical variation in counting rate will affect the baseline shift.
- 3) The noise is also amplified by the BLR1 amplifier and appears at the output. Normally, this noise should be well below the clipping voltage. However, at high count rates, as the baseline approaches the negative clipping level, negative noise peaks will be clipped, which will cause the baseline to begin to shift sooner than in the ideal case. Using a long low-pass time constant minimizes these effects, at the expense of slower recovery should saturation occur.

Since saturation is dependent on duty cycle, using a shorter peaking time, or pulse width, in the shaping amplifier will proportionally increase the saturation count rate. Too short of a peaking time however, will increase the overall noise of the system.

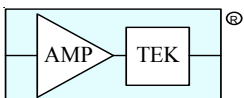

AMPTEK, INC.

14 DeAngelo Drive, Bedford, MA 01730-2204 USA
TEL: +1 (781) 275-2242 FAX: +1 (781) 275-3470
email: sales@amptek.com www.amptek.com